

KiboCUBE Academy

Live Session #1-1

Introduction to CubeSat Technologies

Tohoku University

Department of Aerospace Engineering

Associate Professor Dr. –Ing. Toshinori Kuwahara

This lecture is NOT specifically about KiboCUBE and covers GENERAL engineering topics of space development and utilization for CubeSats.

The specific information and requirements for applying to KiboCUBE can be found at:
<https://www.unoosa.org/oosa/en/ourwork/psa/hsti/kibocube.html>



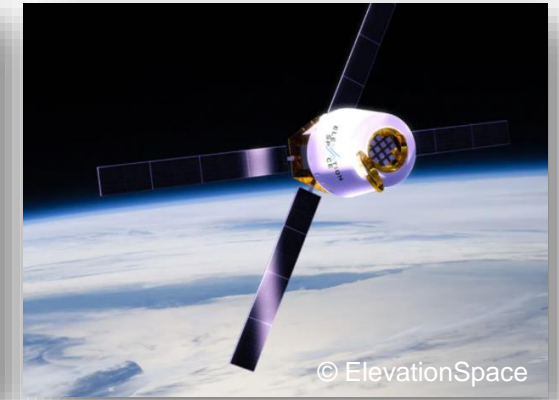
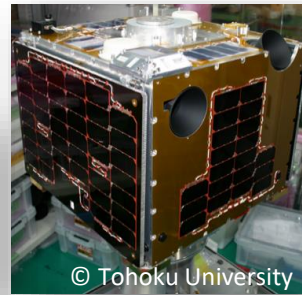
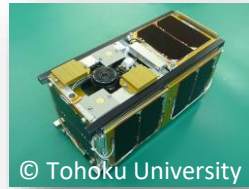

Toshinori Kuwahara, Dr. -Ing.

Position:

2015 - Associate Professor, Department of Aerospace Engineering, Tohoku University

2017 - Technical Advisor, Nakashimada Engineering Works, Ltd.

2017 - Technical Advisor, ALE Co., Ltd.

2020 - Chairperson, University Space Engineering Consortium Japan (UNISEC)

2021 - Co-founder/CTO, ElevationSpace Inc.

Research Topics:

Space Development, Utilization, and Exploration by Small Spacecraft Technologies

Contents

1. Introduction to Space Systems
2. Introduction to CubeSat Systems
3. Definition of Satellite Subsystems
4. CubeSat Payload Systems
5. Ground Station
6. Launch and Operation
7. Conclusion



1. Introduction to Space Systems

1. Introduction to Space Technologies and Utilization

1.1. Access to Space

- Enabling access to space and bringing the benefits of space technology to all countries is important for ensuring the sustainability of future space activities.
- Space technologies affect many areas of our lives and their spin-offs have a vast array of applications here on Earth, ranging from medicine to food security, greatly benefiting our economy and society.
- In space, one can be “ambitious.”

- JAXA/UNOOSA



KiboCUBE Launch, Delivery to the ISS, and Deployment from the ISS © JAXA

1. Introduction to Space Technologies and Utilization

1.2. Satellite Applications

There are a wide range of satellite application which we benefit from.

• Earth Observation

- Meteorological Observation
- Oceanographical Observation
- Geographical Observation
- Coastal Area Observation
- Atmospheric Observation
- Disaster Monitoring and Prevention

• Communication

- Satellite Broadcasting
- Telephone, Internet, etc.

• Navigation

- Global Navigation Satellite System
- Traffic: Air, Land, Water, Railroad, etc.

• Science

- Astronomical
- Microgravity Experiments: Medicine, Pharmacy, Biology, Material Science, etc.
- Moon, Asteroids, Planets, and Deep Space Exploration.

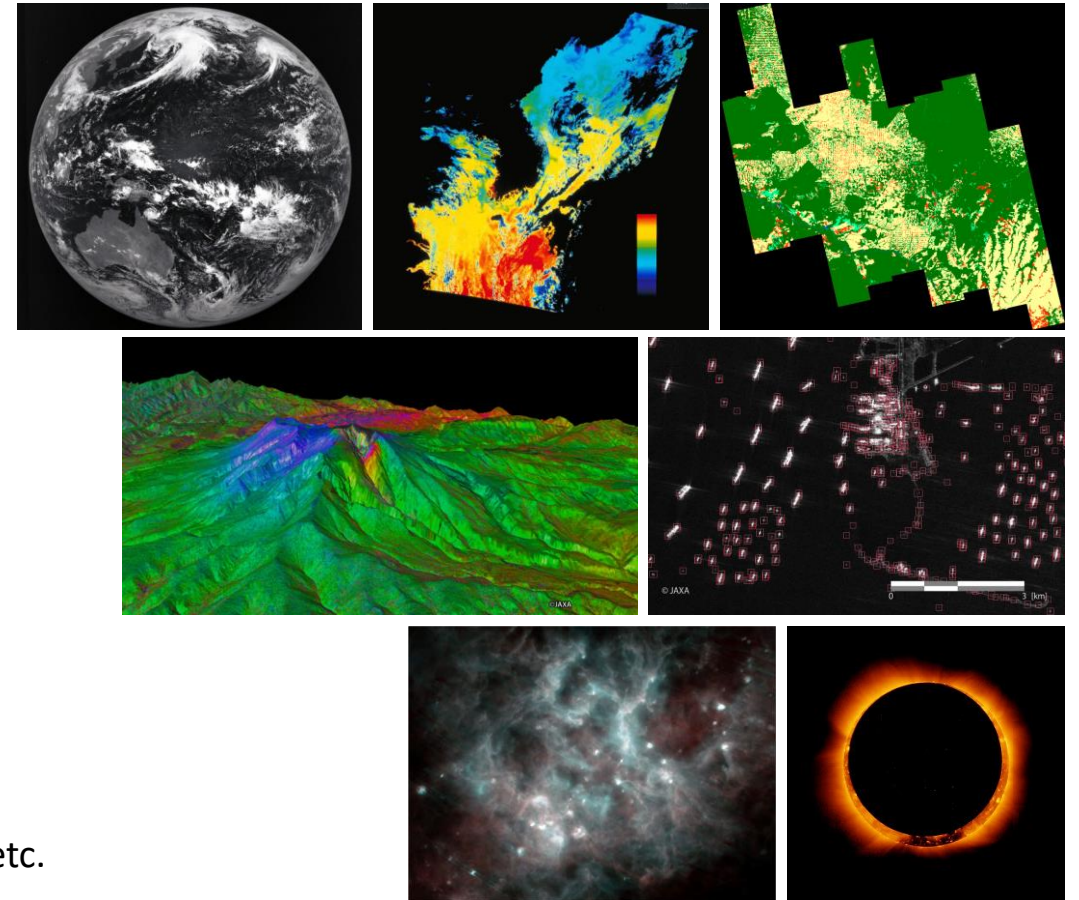

© JAXA

1. Introduction to Space Technologies and Utilization

1.3. Satellite Orbits

- There are many different types of satellite orbits.
- The most appropriate orbit for the mission needs to be selected.
<-> Each mission needs to be designed according to the available satellite orbits.

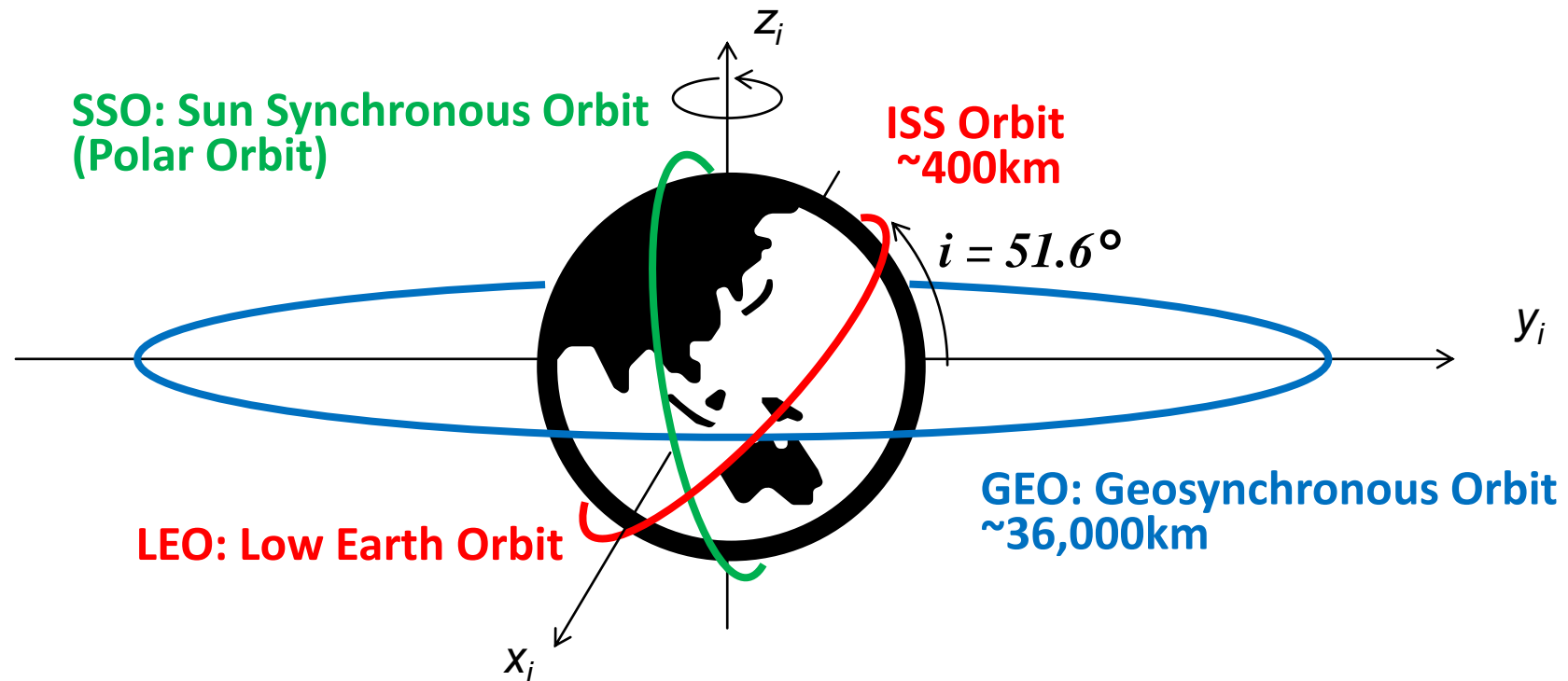

1. Introduction to Space Technologies and Utilization

1.4. Satellite Operation / Ground Station

- Satellites rotate around the Earth, about 16 times per day in the orbit of International Space Station (ISS).
- Earth also rotates once per day.
- Relative velocity between the ground station and the satellite is on the order of about 7.7 km/s.
- Satellite operators have a limited amount of time for communicating with the satellites (about 10 minutes or less per contact, several times a day).
- Satellite operators send commands to satellites from the ground station and receives telemetry data from them.
- For satellite operation, the following aspects must be considered:
 - Satellite Orbit and Mission Lifetime
 - Communication System
 - Ground Station
 - Link Budget Design
 - Operational Phase
 - Regulations

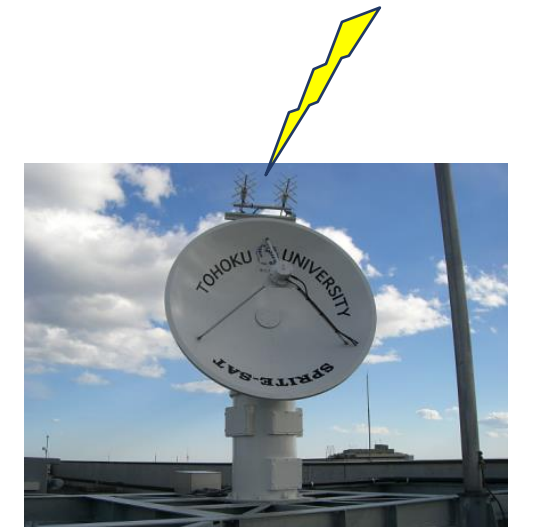
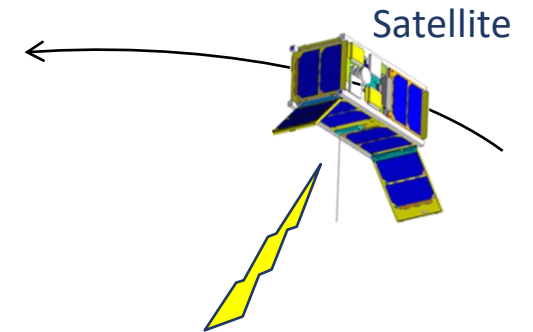

Ground Station

1. Introduction to Space Technologies and Utilization

1.5. Characteristics of Satellite Utilization

- Satellites orbiting in high-inclination orbits can cover a large portion of geographical area on Earth. This feature of global accessibility can be utilized for:
 - Earth observation: periodic, frequent observation of ground area under the satellite orbit.
 - Communication: can have communication contact with ground stations in the visible area.
 - Environmental measurement: can measure the space environment, such as magnetic fields, radiations, etc.
- Higher orbits can have a wider field of view, and lower orbits can facilitate higher ground resolutions of Earth observation.
- Satellites are basically continuously “falling” toward the Earth. This free-fall micro-gravity environment can be utilized for experiments of material science, bioscience, medicine, etc.
- Space also provides unique environments such as vacuum, high radiation, strong ultraviolet light, cold and hot temperature, and existence of atomic oxygen and plasma, etc.

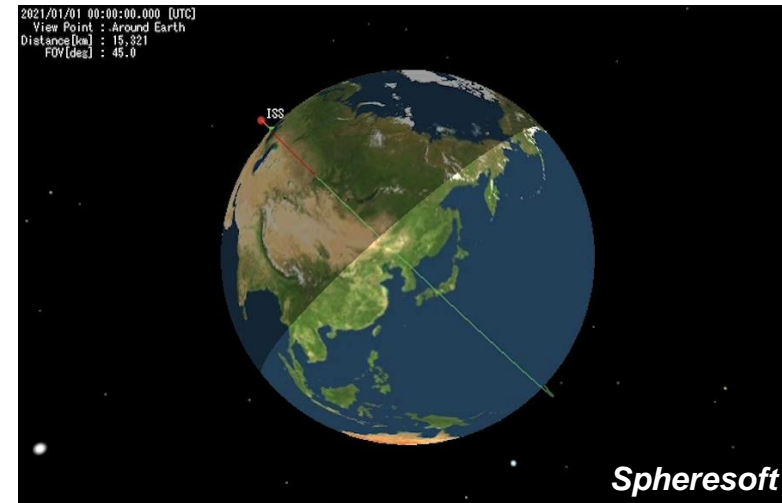

1. Introduction to Space Technologies and Utilization

1.6. Orbit of International Space Station (ISS)

- Orbit of ISS:
 - Orbit altitude: $\approx 400\text{km}^*$
 - Inclination: $\approx 51.6\text{ deg}$
 - Orbital period: $\approx 91\text{ min}$
 - * Orbit altitude changes for about $\pm 20\text{km}$
- CubeSats deployed from the ISS stay in almost the same orbit as the ISS.
- Slight differences in initial relative velocity and different mechanical characteristics, such as mass and shape (and hence, ballistic coefficient), make the CubeSats separate from each other into different orbits.
- ISS orbit covers the ground surface of regions with lower latitude (between $\pm 51.6\text{ deg}$).
- ISS rotates around the Earth about 16 times a day, while the Earth rotates about 22.5 deg during the 1 orbital period of the ISS.

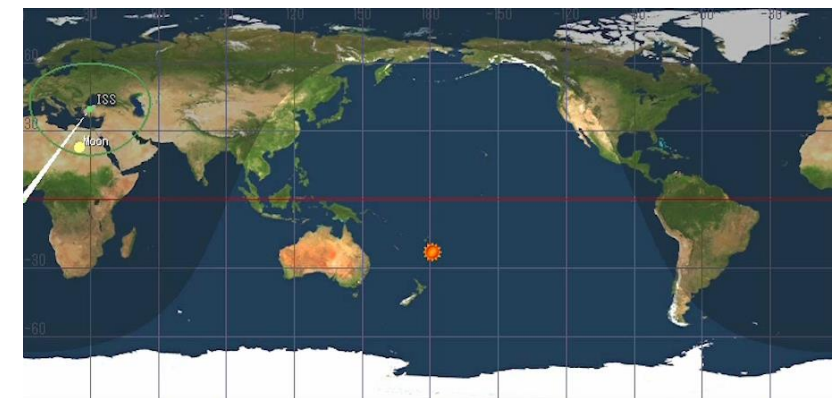
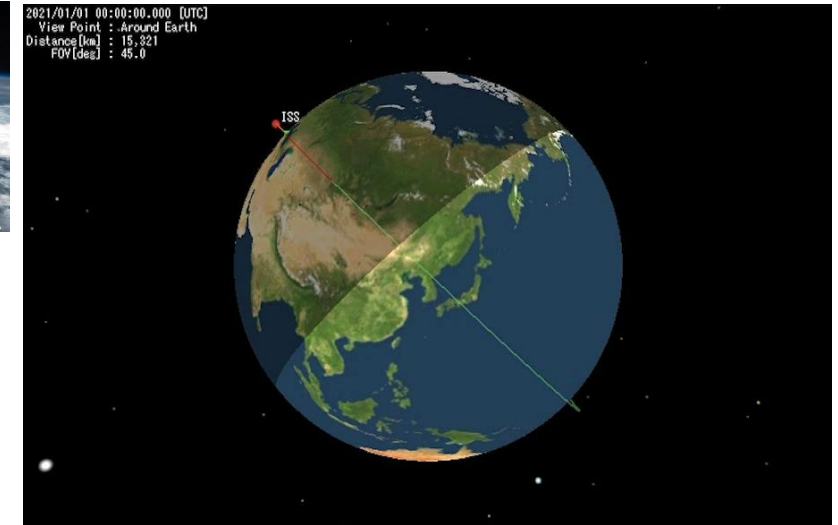

Spherosoft

1. Introduction to Space Technologies and Utilization

1.7. General Engineering Aspects

- Satellites cannot be repaired in orbit after they are launched. You can only communicate with them in order to conduct planned missions, solve unexpected problems, or upgrade the functionalities.
- Satellites need to be self-sustaining in orbit in terms of:
 - Power generation, storage, and management
 - Thermal control
 - Communication
 - Attitude determination and control
 - Data handling
 - Mission control
- Thorough operational scenarios and procedures need to be developed and the satellite operators need to be well trained before the launch.



2U CubeSat RAIKO



Satellite Operators

© Tohoku University



2. Introduction to CubeSat Systems

2. Introduction to CubeSat Systems

2.1. Characteristics of Small Space Systems

Comparison between large and small satellites:

Large Satellite

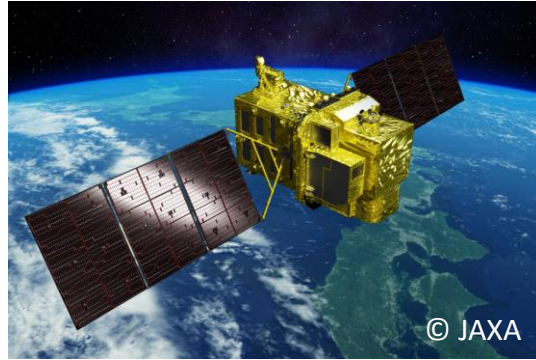

Large
High
Long

- Dedicated launch
- Need high-reliability, low-risk
- High-performance,
Low observation frequency



Mass
Cost
Development Time

Small Satellite

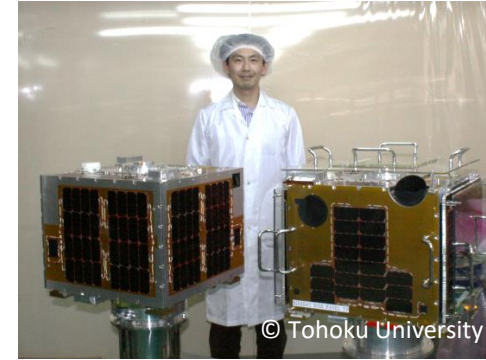

Small
Low
Short

- Small mass = **Frequent launch** opportunities
- Low cost = Can try **challenging missions**, realize large constellations/networks (**Frequent Observations**)
- Rapid Development = Can utilize **brand new technologies**
- **Suitable platform for space education and rapid technology demonstration**

2. Emerging Technologies of Small Space Systems

2.2. Mass Categories

Small, Micro, Nano, and Pico-satellites.

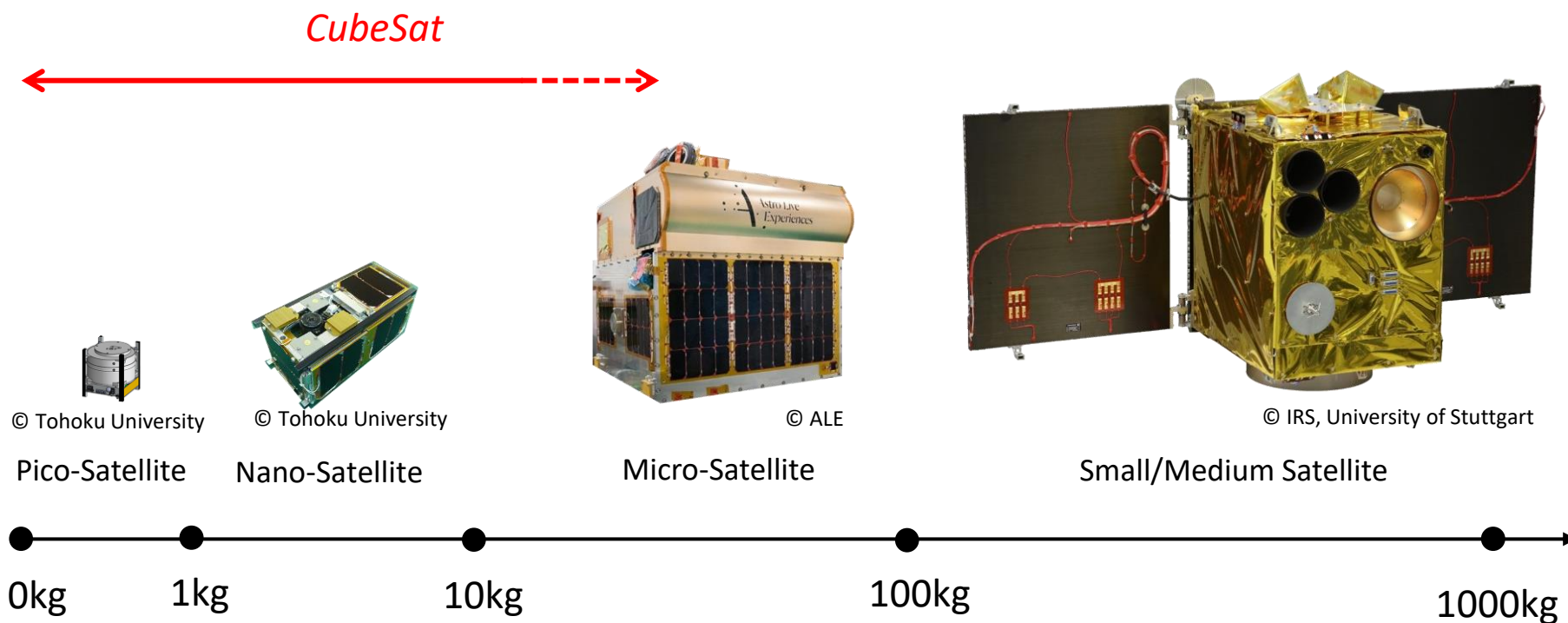

2. Introduction to CubeSat Systems

2.3. CubeSat Standardization History

Some standards are available:

- CubeSat Design Specification rev.13 (2014/2/20)
6U CubeSat Design Specification rev. 1.0 (2018/6/7)
- California Polytechnic State University
(<https://www.cubesat.org/>)
- CubeSat Subsystem Interface Definition version 1.0
- UNISEC Europe (2017/8/24)
(<http://unisec-europe.eu/wordpress/wp-content/uploads/CubeSat-Subsystem-Interface-Standard-V2.0.pdf>)
- ISO Space systems – Cube satellites (CubeSats)
(<https://www.iso.org/standard/60496.html>)
- JEM* Payload Accommodation Handbook Vol.8 D
- JAXA (* Japanese Experiment Module (JEM) = Kibo)
(<https://iss.jaxa.jp/kibouser/provide/j-ssod/#sw-library>)
English (2020/7/31)
(https://humans-in-space.jaxa.jp/kibouser/library/item/jx-esp_8d-d1_en.pdf)
Japanese (2020/5/25)
(https://humans-in-space.jaxa.jp/kibouser/library/item/jx-esp_8d-d1.pdf)

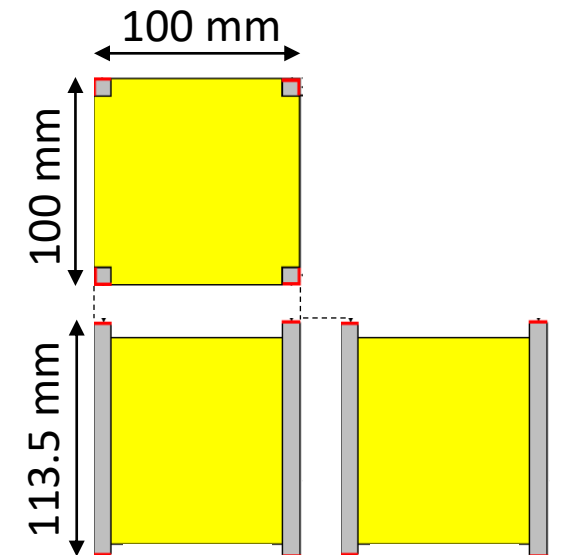
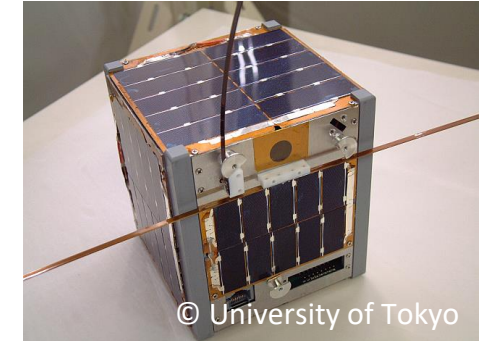

1 Unit: 10 cm cube, 1.33kg

2. Introduction to CubeSat Systems

2.4. Kibo Release Opportunities

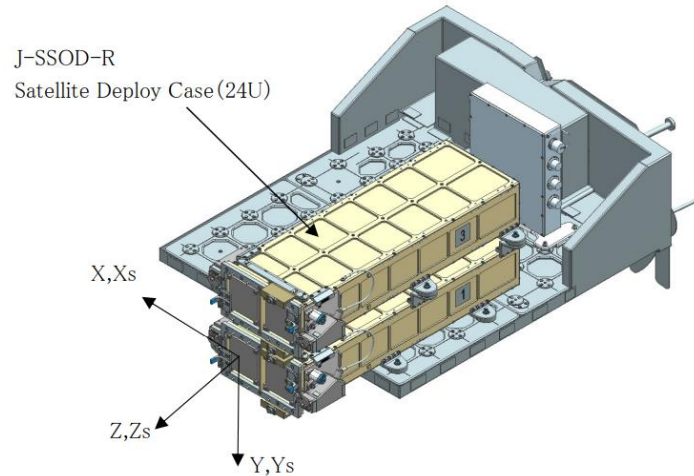
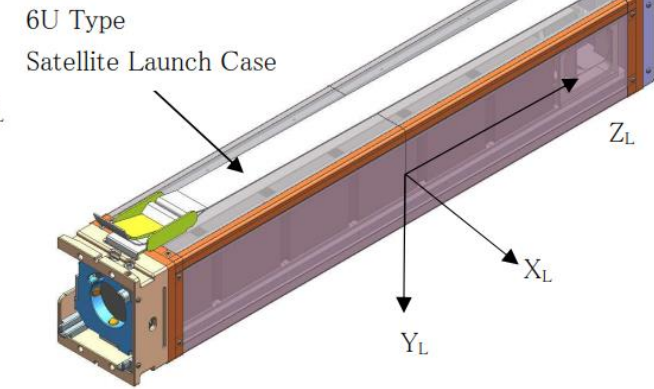
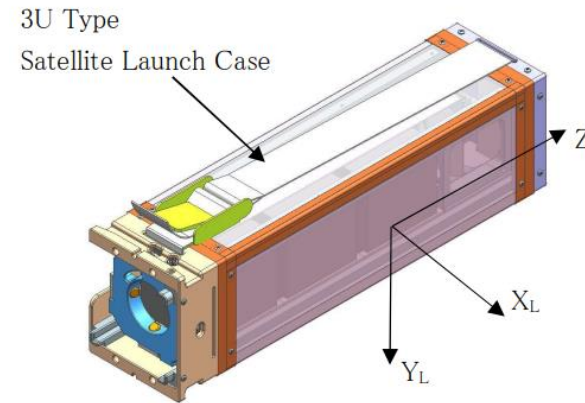
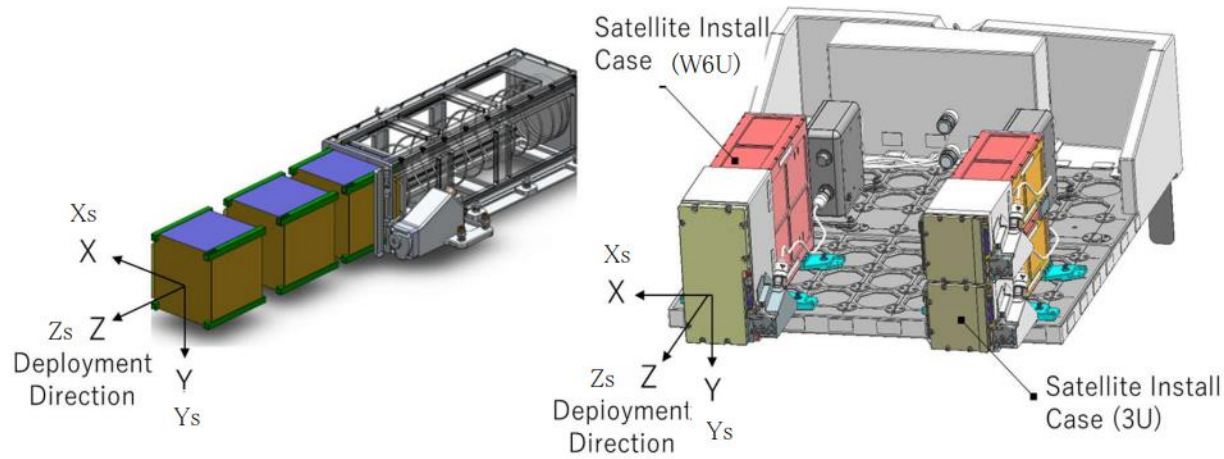

		Exterior Dimensions (*1)	Rail Dimension	CubeSat Installation
10cm Class satellite	1U	X:100×Y:100×Z:113.5mm	More than 8.5mm squares	Ground / ISS
	1.5U	X:100×Y:100×Z:170.2mm		ISS
	2U	X:100×Y:100×Z:227.0mm		Ground / ISS
	3U	X:100×Y:100×Z:340.5mm		Ground / ISS
	4U	X:100×Y:100×Z:454.0mm		ISS
	5U	X:100×Y:100×Z:567.5mm		ISS
	6U	X:100×Y:100×Z:681.0mm		ISS
	W6U	X:100×Y:226.3×Z:340.5 or 366.0mm		Ground

(*1) Nominal dimension including rails

Reference: JEM Payload Accommodation Handbook Vol. 8 D

https://iss.jaxa.jp/kibouser/library/item/jx-escp_8d.pdf

2. Introduction to CubeSat Systems

2.5. 1U CubeSat

- Best platform to learn essential engineering skills and technologies for satellite development and operation.
- A 1U CubeSat is the simplest implementation. Larger formats can be selected depending on the technology level and mission requirements.
- Smaller formats are mainly for fundamental functionalities .
- Larger formats are required for missions which require larger sensors, attitude control, and large amount of data transfer.

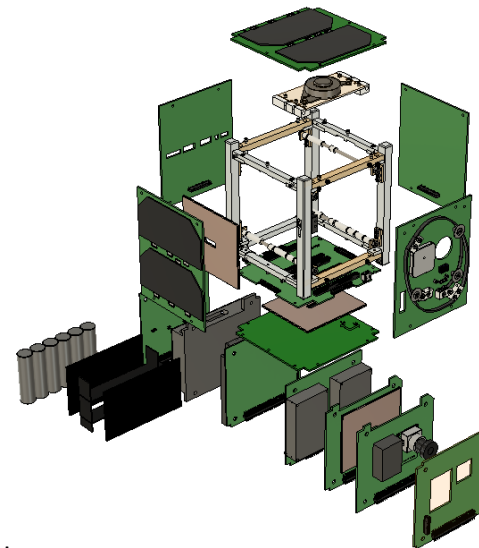
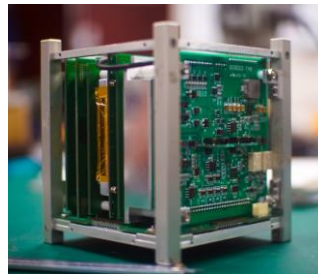

© Kyutech

2. Introduction to CubeSat Systems

2.6. CubeSat Components

- Some CubeSat components are commercially available for quick access to space.

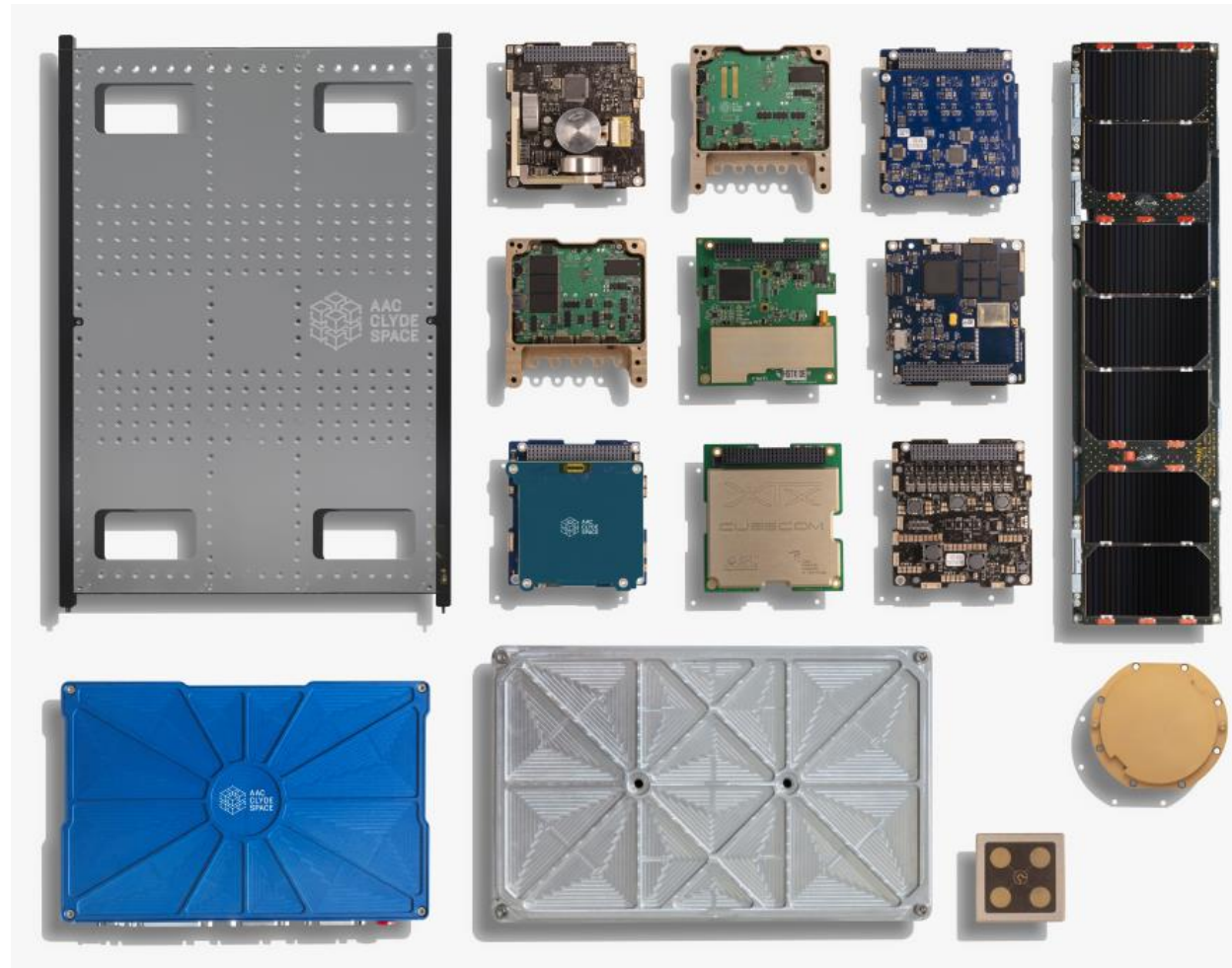

© AAC Clyde Space



3. Definition of Satellite Subsystems

3. Definition of Satellite Subsystems

3.1. Satellite Subsystems

A satellite system consists of several subsystems. Typical categorization is as follows:

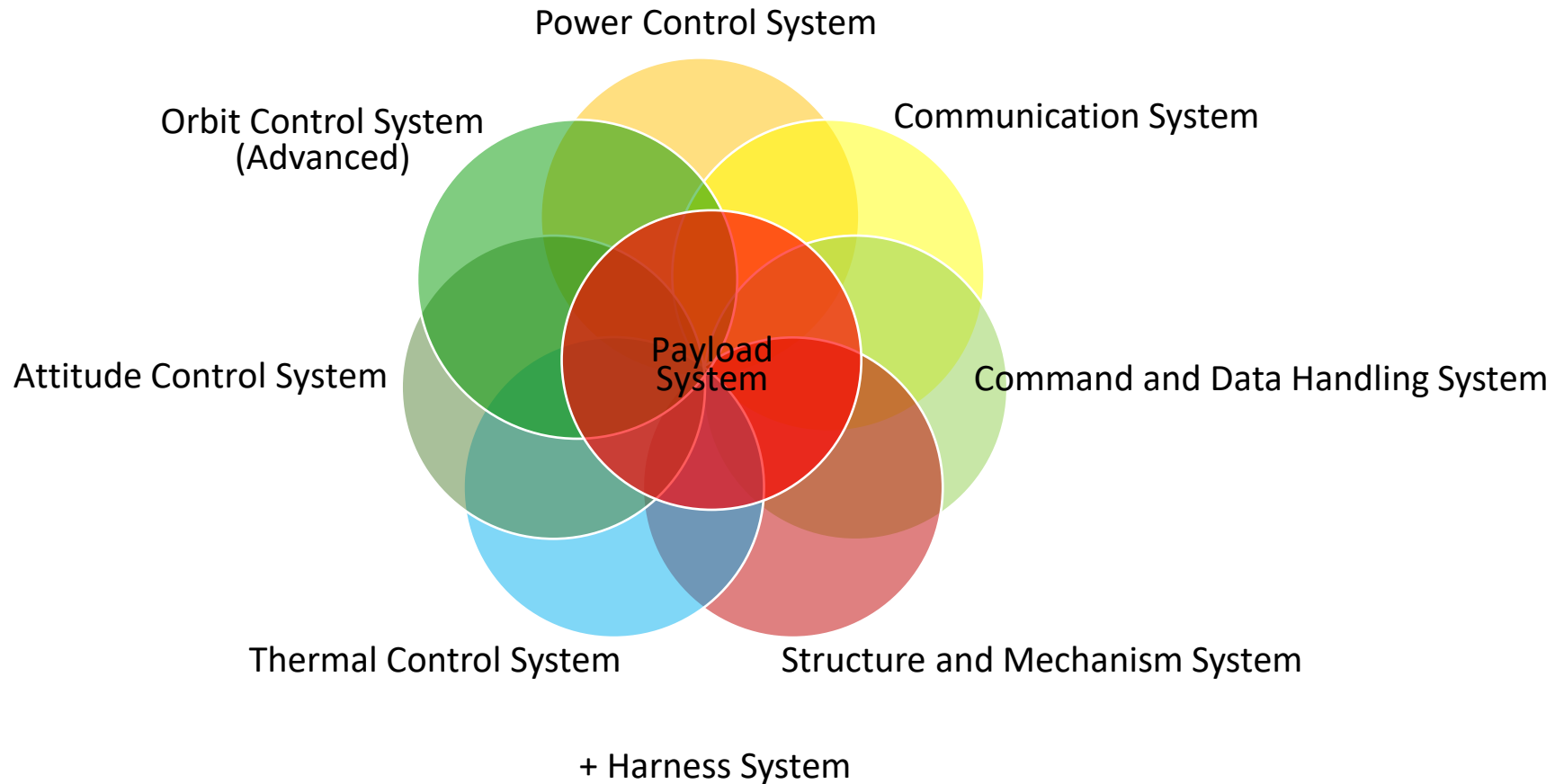

3. Definition of Satellite Subsystems

3.2. Power Control System

- Power control systems manage power generation by solar panels, storage into secondary batteries, and distribution to the satellite components.
- Power control systems shall be highly reliable, as compared to other on-board components.
- The size of solar cells and capacity of the battery shall be determined based on the power consumption requirements of the satellite mission.

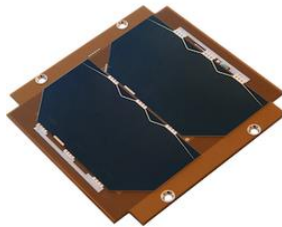
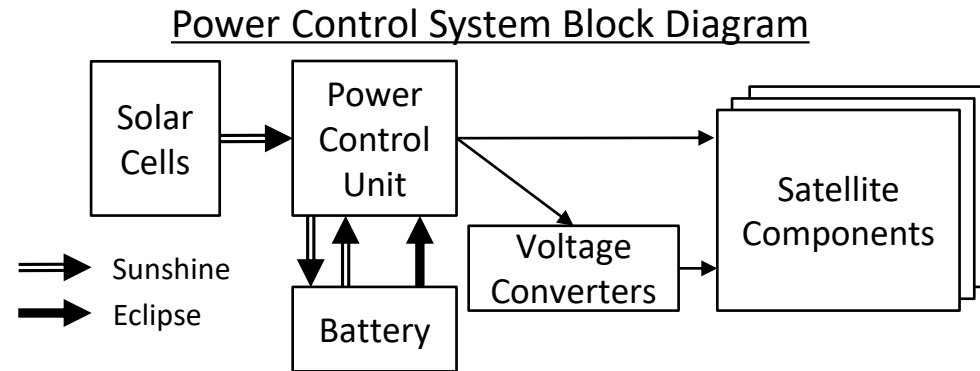

Solar Array and Battery ©GomSpace



Electrical Power Control System
© AAC Clyde Space



Integrated Power management and
communication system © Addnics corp.

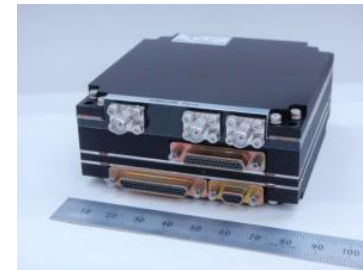

3. Definition of Satellite Subsystems

3.2. Power Control System

- Example of 2U CubeSat “RAIKO”

Power	
solar cells	ZTJ Photovoltaic Cell (>29.5% efficiency) 2 series x 6 parallels (no paddle open) 2 series x 10 parallels (paddle opened)
batteries	8-cell NiMH (total 750mAH, 9.6V)
power generation	3.19 W (avg. in sunshine, no paddle open) 4.70 W (avg. in sunshine, paddle opened)
power consumption	4.90 W (communication mode) 1.05 W (standby mode)

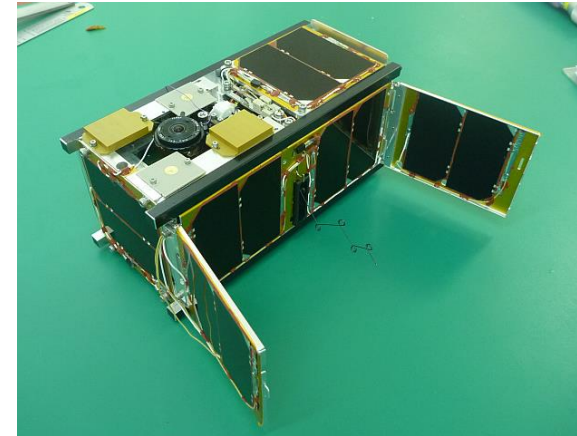

2U CubeSat RAIKO © Tohoku University

3. Definition of Satellite Subsystems

3.3. Communication System – Transmitter/Receiver

- As the satellite operates remotely in space, information exchange through communication is indispensable to make the mission of the satellite meaningful.
- The communication throughput (amount of data), especially for the down-link, determines/limits the entire performance of the satellite system itself.
- For high-speed communication, higher electrical power is required, and the temperature of the transmitter increases. (Typically a ground contact lasts about 10 minutes or less.)
- Receiver shall be ideally powered on all at all times, so that the satellite doesn't miss any commands sent from the ground station. The transmitter can be turned on and off according to the ground contact schedule.
- The amount of mission data down-link can be increased by using more than one ground station if available. Collaborative satellite operation is very useful.

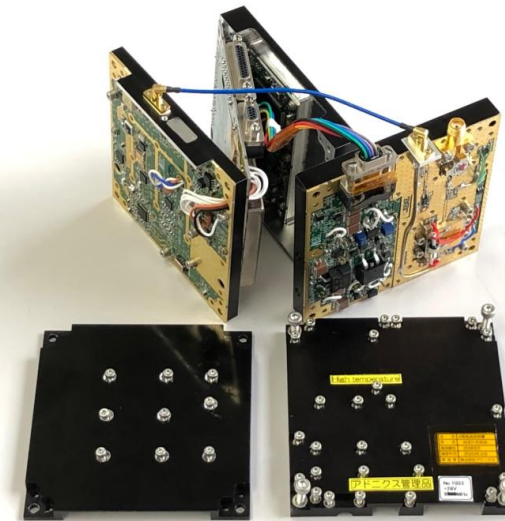
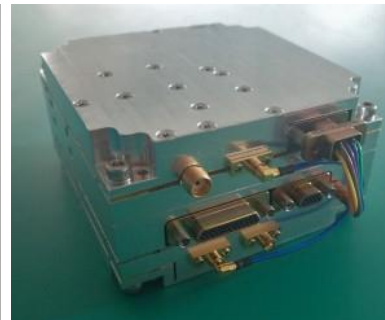

CubeSat S-band RF Transmitter and Receiver, X-band Transmitter, and inside of the X-band Transmitter (from left to right) © Addnics corp.

3. Definition of Satellite Subsystems

3.3. Communication System – Antenna

Low Frequency / Long Wavelength

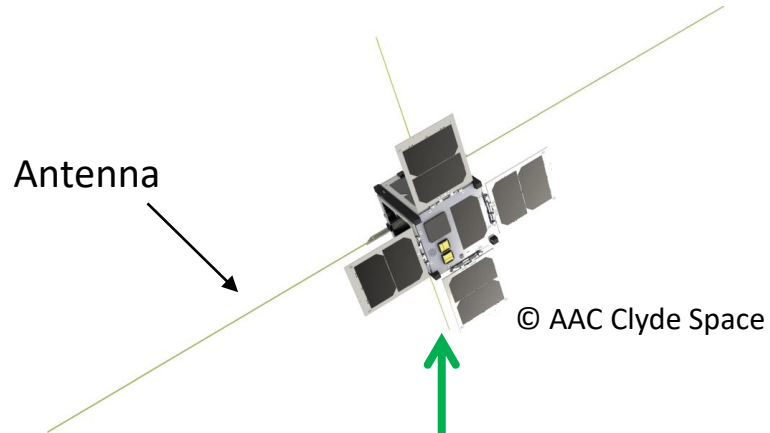

Yagi-Antenna for VHF-band

High frequency / Short Wavelength

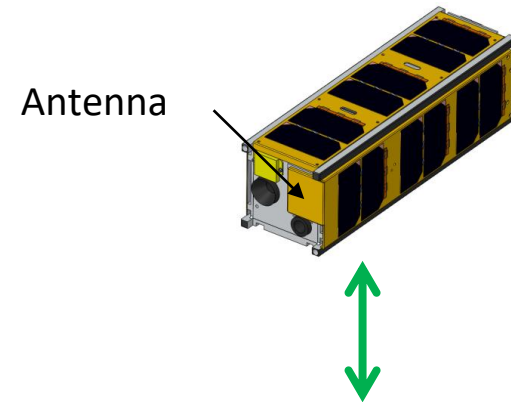

Dish-Antenna for S-Band

3. Definition of Satellite Subsystems

3.4. Command and Data Handling System

- Command and Data Handling System, often denoted as C&DH, manages data handling, components commanding/monitoring, data storage, signal processing (for communication), and error handling inside the satellite.
- Certain levels of autonomous functions need to be implemented in C&DH so that satellites can survive in the space environment.
- A high level of reliability is required for the C&DH computers. When errors occur, due to e.g. radiation effects, the power control system shall power cycle (power off and on) the computer either autonomously or by telecommand from the ground station.

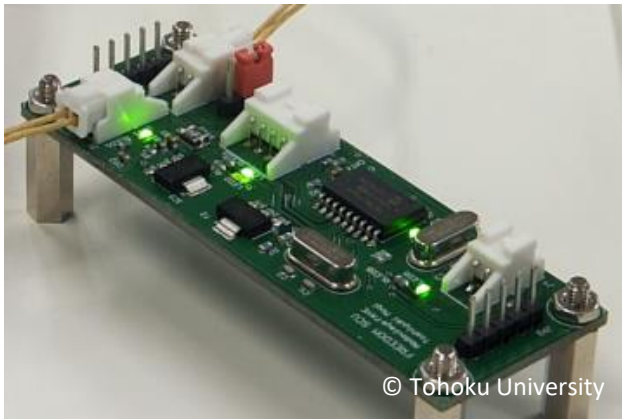

PIC Computer

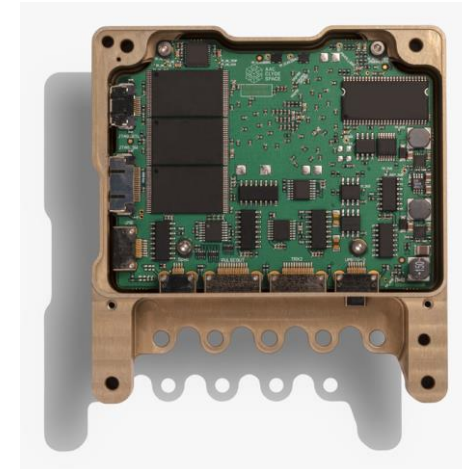
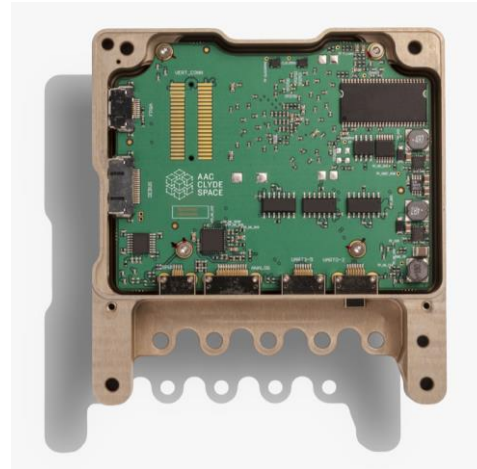

High-end CubeSat On-board Computers © AAC Clyde Space

3. Definition of Satellite Subsystems

3.5. Structure and Mechanism System

Structure System

- Is the main interface with the launch vehicle. In case of CubeSats, the rails are the contact points between the satellite and the pod.
- The outer dimensions, surface area, and surface treatment of the rails and outer envelope of the entire satellite are specified.
- The structure system shall withstand a launch environment, such as vibration, static acceleration, shock, (acoustic, air venting), etc.

Mechanical System

- Includes separation switches, deployable antennas, deployable solar panels, shutters, booms, and any other mechanically moving elements on the satellite.
- The mechanical system shall be safely stowed during the launch to ensure the secure deployment of the CubeSat from the pod.

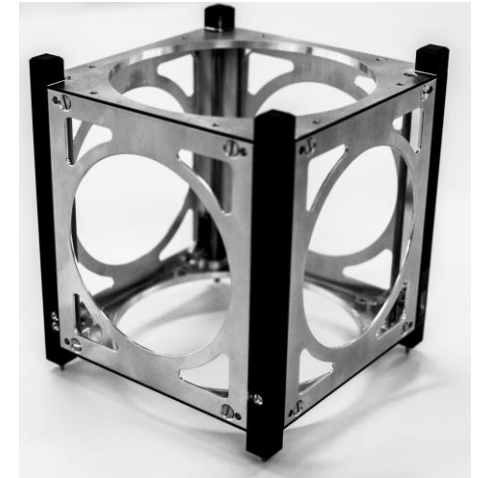

1U CubeSat Structure



Deployable Solar Panel for 3U CubeSat
© AAC Clyde Space

3. Definition of Satellite Subsystems

3.6. Thermal Control System

- Thermal control of a satellite can be achieved in two different ways:
 1. Passive control
 2. Active control
- As active control needs electrical power (heaters/coolers) in general, passive control is the usual thermal control concept of CubeSats.
- Passive thermal control utilizes different surface materials with different thermo-optical characteristics in order to adjust the heat exchange between deep space and the Earth.
- Aluminum surface contributes to warming up the temperature.
- Kapton surface contributes to cooling down the thermal condition.

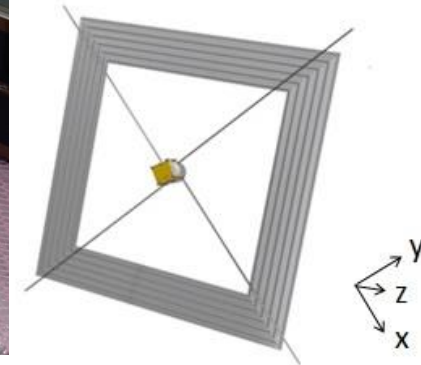

1U CubeSat FREEDOM
Nakashimada Engineering Works, Ltd.

Example of 1U CubeSat “FREEDOM”

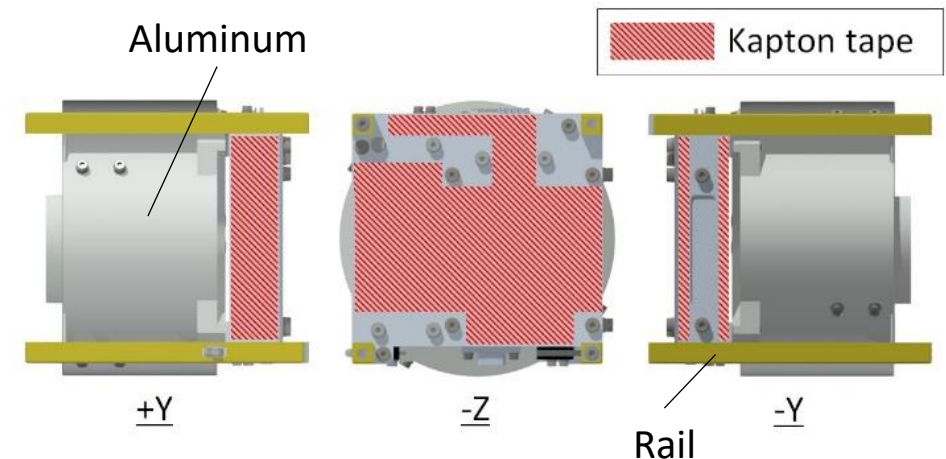

3. Definition of Satellite Subsystems

3.7. Attitude Control System

- Attitude control capability is required depending on the mission operation of the satellite, such as:
 - Pointing observation instruments toward the target
 - Pointing high-gain antenna toward the ground station for high-speed communication
 - Orienting solar panels toward the sun for larger power generation
- For the attitude control, attitude determination is also necessary beforehand, therefore attitude determination sensors and attitude control actuators are required.
- Type of attitude control
 1. Passive control
 2. Active control
- Attitude control modes
 1. Detumbling control (after the separation from the launch vehicle or release from the ISS).
 2. Pointing control: inertial, nadir, target, velocity direction, etc.

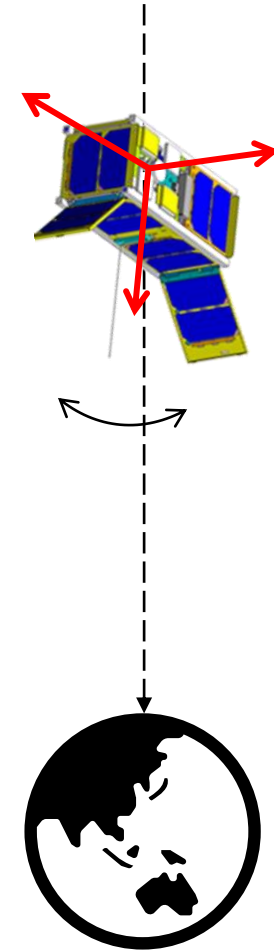

3. Definition of Satellite Subsystems

3.7. Attitude Control System – Detumbling Control

Detumbling Control

- Satellites can experience high rotational rates after the separation from the launch vehicle, or deployment from the ISS.
- In general, satellites in a high-speed rotation cannot communicate with the ground station properly.
- Satellites shall be able to detumble and reduce the rotational speed down to about several degrees per second.

Type of detumbling control

1. Active control

- Generate magnetic moment by means of magnetic torquers to interact with the Earth's magnetic field to actively slow down the rotational rate.

2. Passive

- Utilize permanent magnets and magnetic hysteresis dumpers to passively slow down the rotational rate.

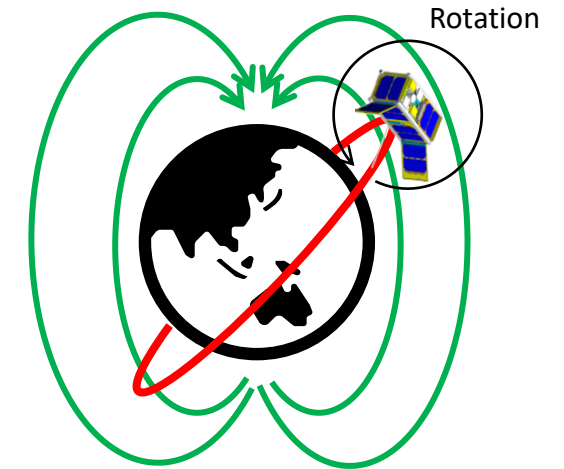

Earth Magnetic Field



Magnetic Torquers
(Electrical Coil)

3. Definition of Satellite Subsystems

3.7. Attitude Control System – Gravity Gradient Control

Gravity Gradient Control (passive control)

- Satellites with long shapes and spread mass distribution experience a gravity gradient torque such that the longitudinal direction points toward the Earth.
- Cameras, antennas, and sensors can be pointed toward the Earth without additional electrical power for the attitude control.
- Pointing accuracy is relatively low.
- Can be combined with active attitude control with some attitude control actuators, such as magnetic torquers and reaction wheels.

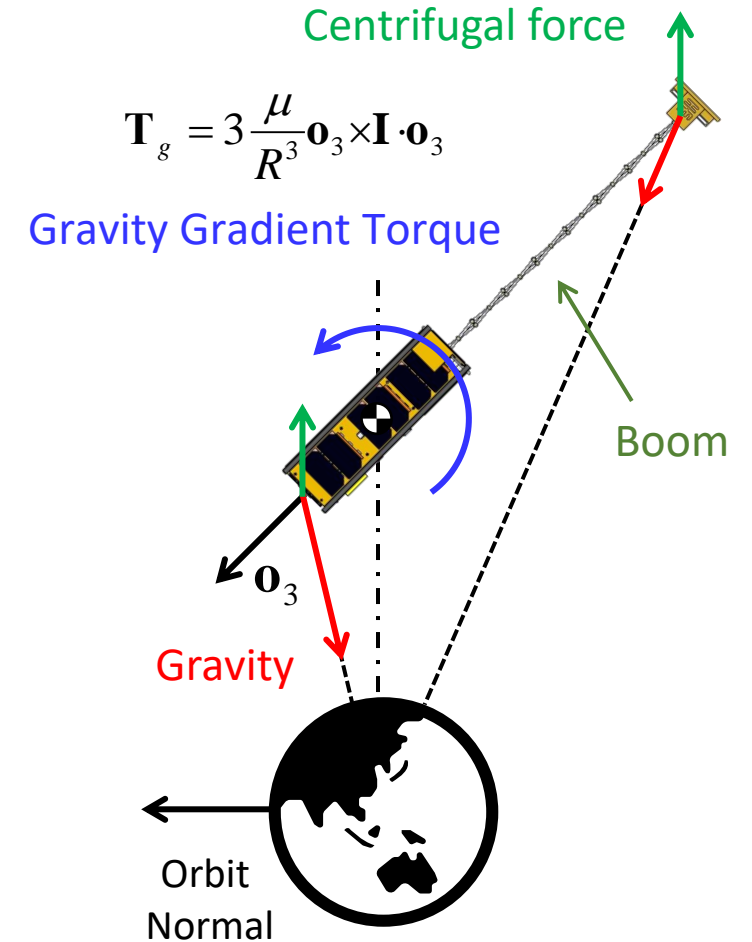

μ : gravitational constant, R : orbit radius

\mathbf{o}_3 : observation vector (Z - axis)

3. Definition of Satellite Subsystems

3.7. Attitude Control System – 3-axis Control

Active 3-axis Control

- Attitude control actuators such as magnetic torquers and reaction wheels are used for active 3-axis control.
- Reaction wheels can realize agile and stable attitude control.
- Disturbance torques acting on the satellite gradually accumulate as angular momentum stored in the reaction wheels. Reaction wheels cannot be operated for a long time without desaturation using magnetic torquers.
- Satellite attitude shall be determined precisely by means of a combination of attitude determination sensors.

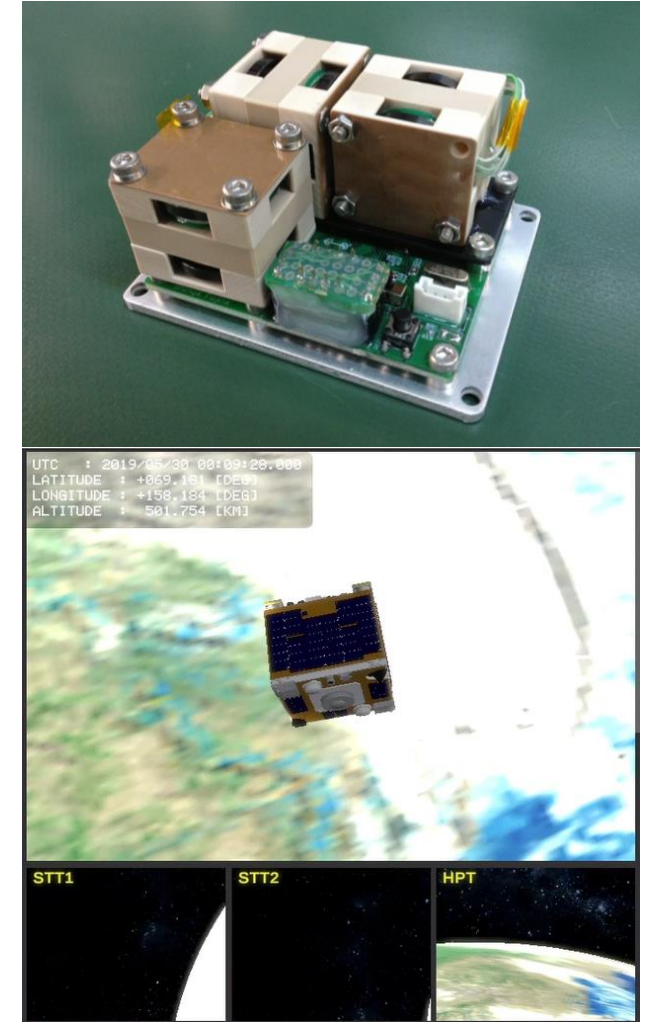

© Tohoku University

3. Definition of Satellite Subsystems

3.8. Payload System

- The on-board components dedicated to the satellite's missions.
- Good practice is to define clear interfaces (mechanical and electrical) with the bus system.

Example of 3U CubeSat "S-CUBE"

- 1U is assigned for the payload instruments
- 2U is assigned for satellite bus system

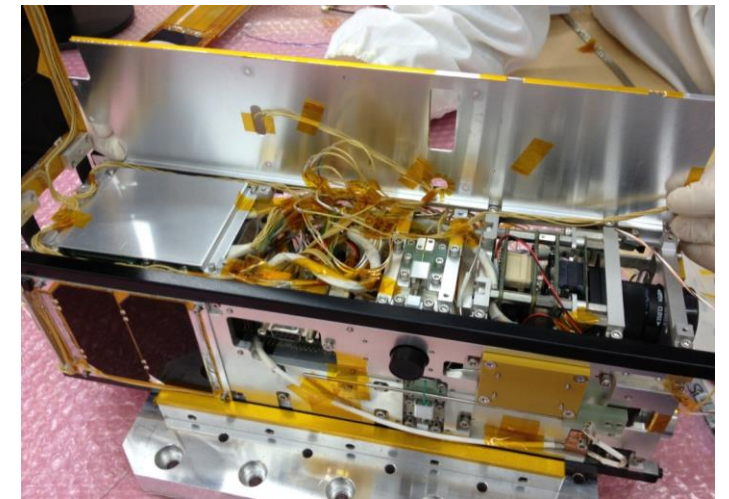
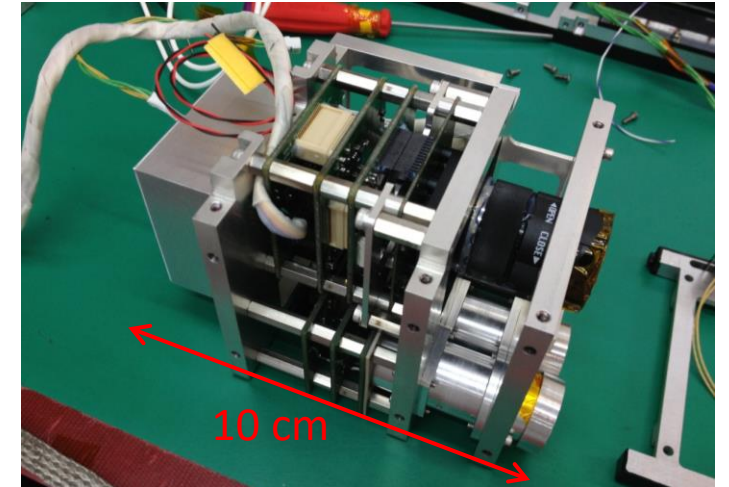
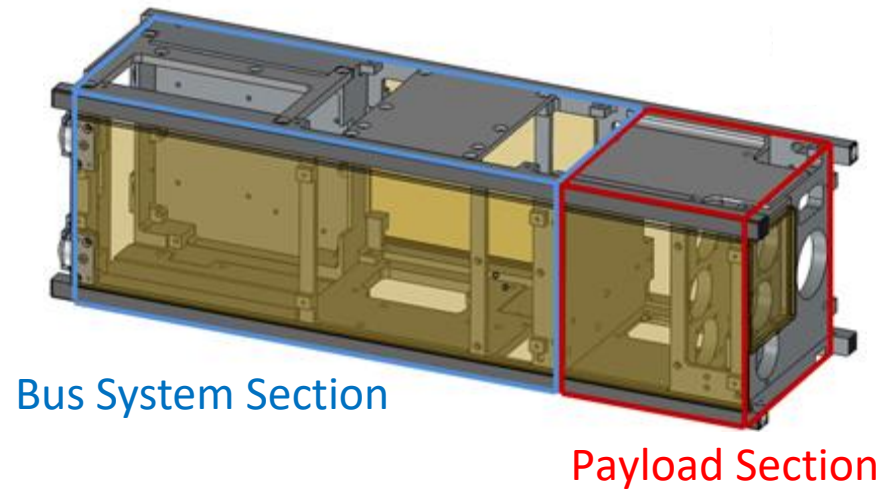

3U CubeSat S-CUBE © Chiba Institute of Technology / Tohoku University

3. Definition of Satellite Subsystems

3.9. Harness System

- The harness system is not negligible! It affects the handling ability during satellite system integration.

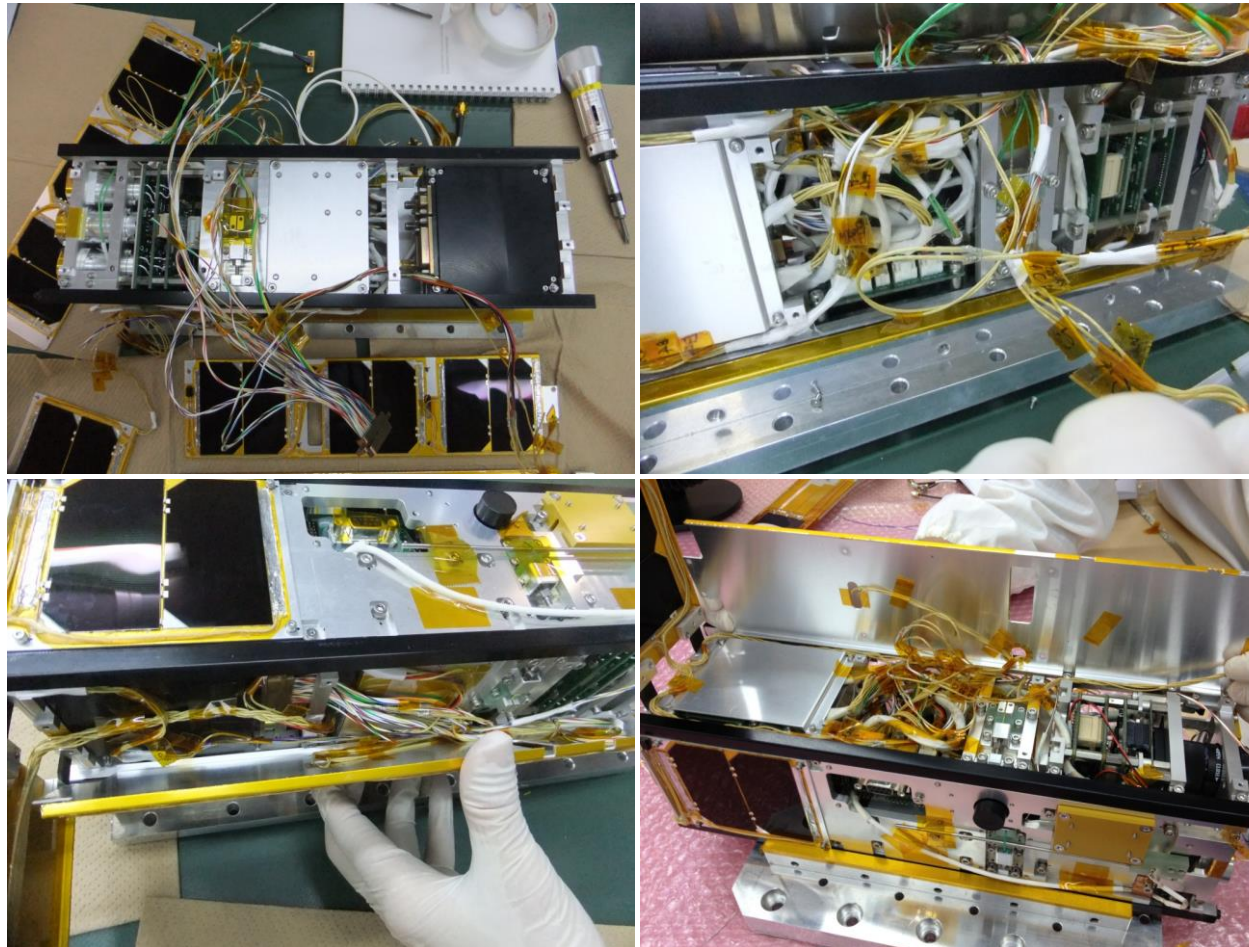

3U CubeSat S-CUBE © Chiba Institute of Technology / Tohoku University



4. CubeSat Payload Systems

4. CubeSat Payload Systems

4.1. Types of Payload Systems

Each CubeSat has its own mission. The larger the CubeSat is, the more payload instruments can be carried and the more advanced the missions are that can be conducted.

Examples of CubeSat payload instruments.

- Observation cameras (Earth, Planetary, Astronomy, etc.)
- In-situ space environment measurement sensors
- Meteor measurement sensors
- Communication instruments
- Engineering demonstrations
 - Deployment mechanisms
 - Advanced technologies (new sensors, electrodynamic tether, etc.)

Some examples are illustrated in the following slides.

4. CubeSat Payload Systems

4.2. Earth Observation Camera System

Example of 2U CubeSat “RAIKO”

- Earth Observation Camera System
- New sensor: Star Tracker

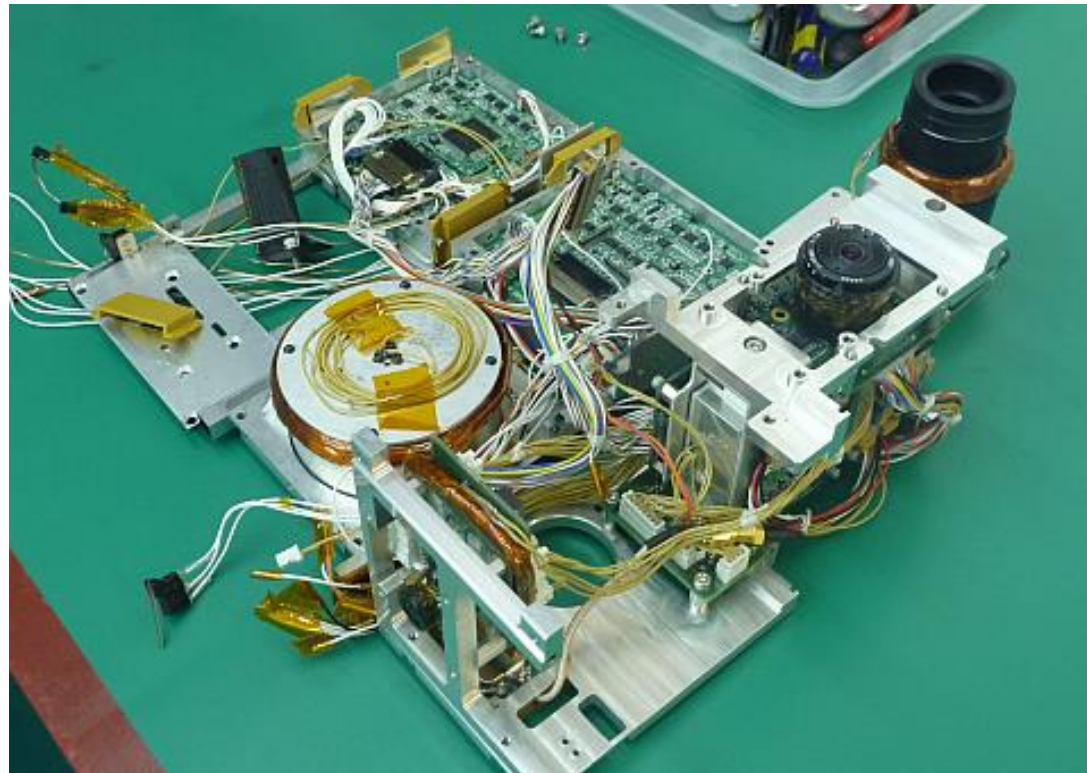

2U CubeSat RAIKO © Tohoku University

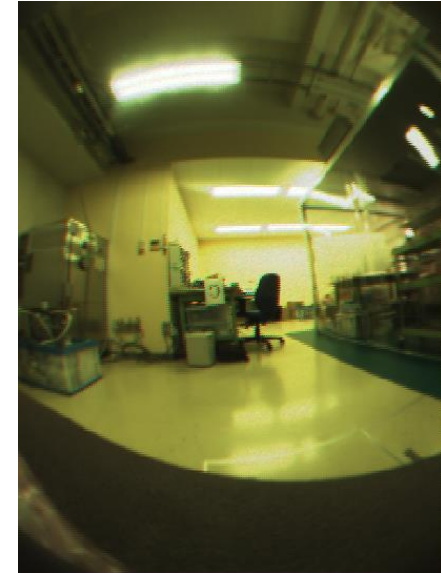

4. CubeSat Payload Systems

4.3. Meteor Observation

Example of 3U CubeSat "S-CUBE"

- Meteor Observation Camera System
- Gravity Gradient Boom
- Deployable Solar Panels

A gravity gradient boom was used to point the meteor observation camera toward the Earth's atmosphere for detection of incandescent meteors as they enter the atmosphere.

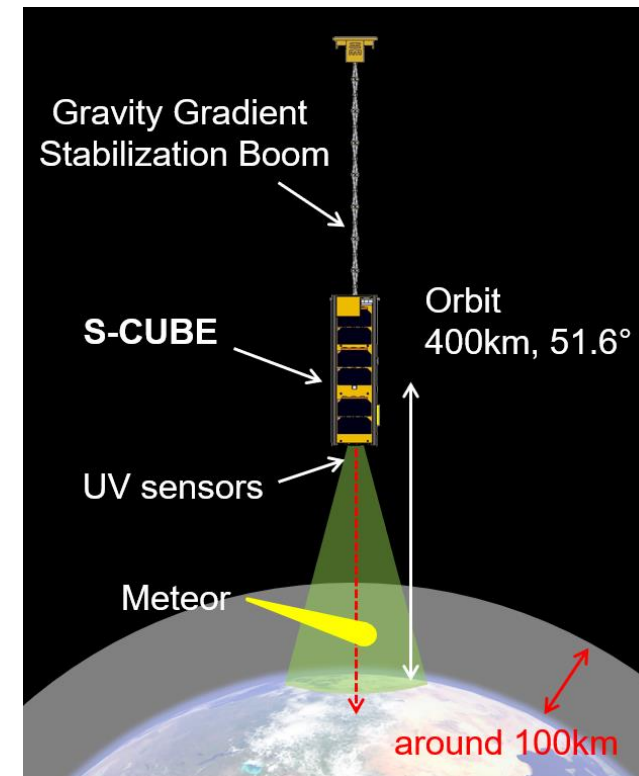
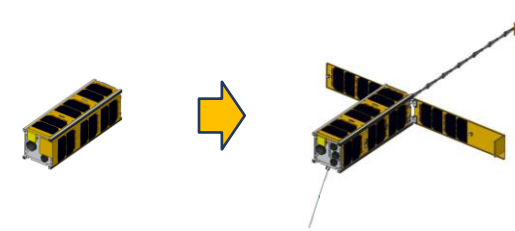
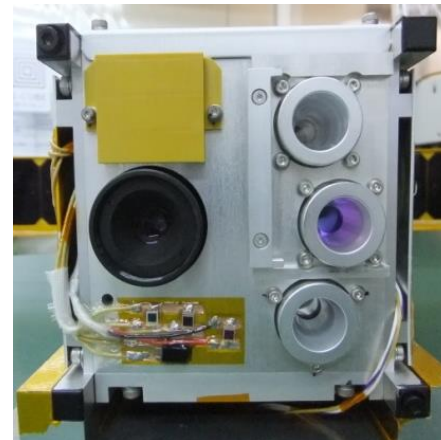
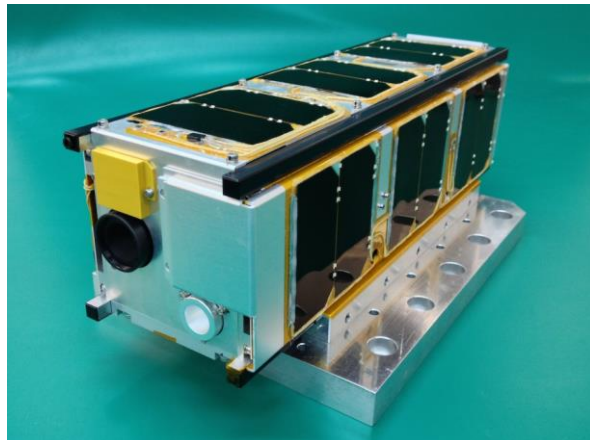

3U CubeSat S-CUBE © Chiba Institute of Technology / Tohoku University

4. CubeSat Payload Systems

4.4. Signal Measurement Instrument

Example of 3U CubeSat

- AIS (Automatic Identification System) signal receiver
- Deployable directional antenna

A 3-axis attitude control was utilized to point the antenna toward the Earth for detecting AIS signals sent from ships which track the positions of the ships with a higher geographical resolution.

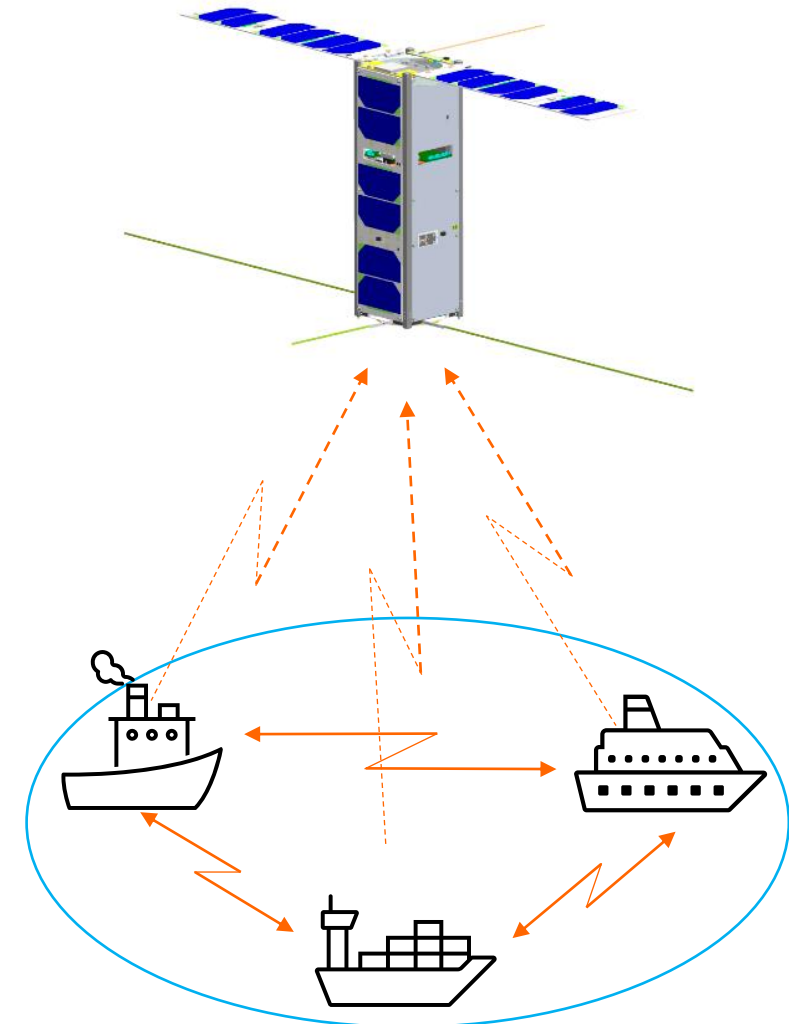
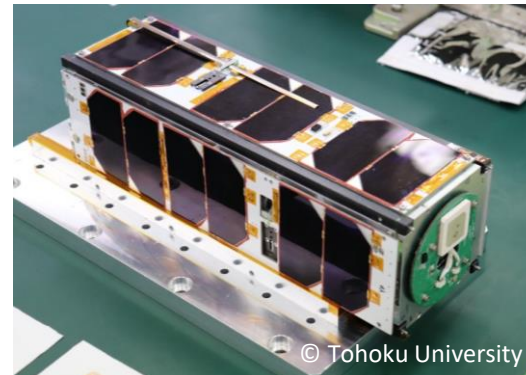
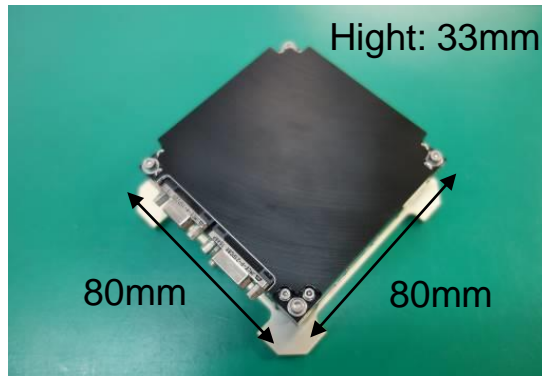

4. CubeSat Payload Systems

4.5. Deployment Mechanism – De-orbit Sail

Example of 1U CubeSat “FREEDOM”

- De-orbit sail for fast de-orbiting and re-entry into Earth atmosphere from ISS orbit.
- No communication system, no solar cells.

FREEDOM demonstrated on-orbit deployment of the thin-film based de-orbit sail, which can be utilized for space debris mitigation and prevention using atmospheric drag.

This successfully demonstrated device is now available for CubeSats and micro-satellites.

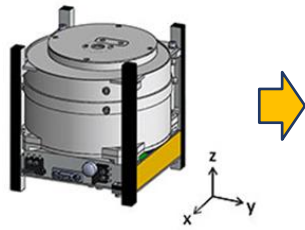

1U CubeSat FREEDOM © Nakashimada Engineering Works, Ltd. / Tohoku University

Orbit Altitude of FREEDOM and ITF-2

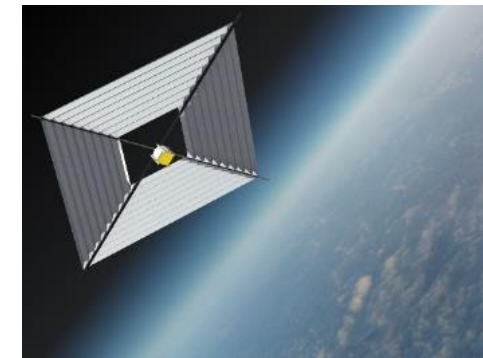
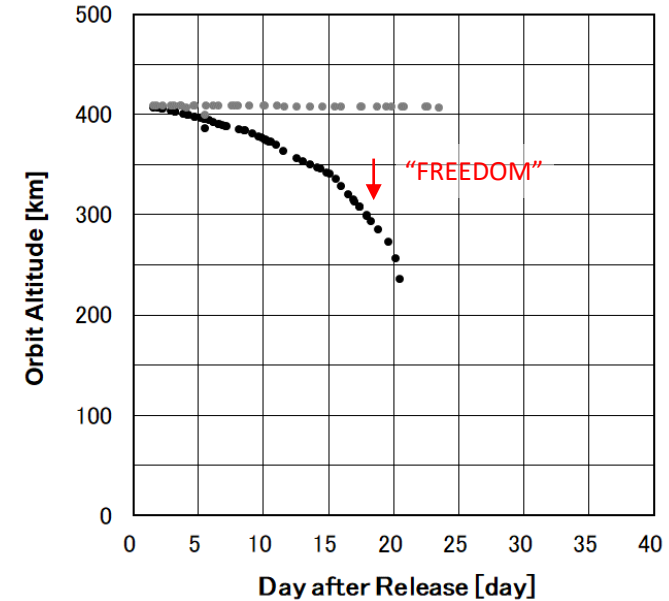

4. CubeSat Payload Systems

4.6. Engineering Demonstration – Electrodynamic Tether

Example of 3U CubeSat “ALE-EDT”

- Electro-dynamic tether for de-orbiting and re-entry into Earth atmosphere.

3-axis attitude control is used to control the satellite attitude during the extension of the electrodynamic tether. The device will be useful for space debris mitigation and prevention in higher altitude orbits, as it can operate independent of atmospheric drag.

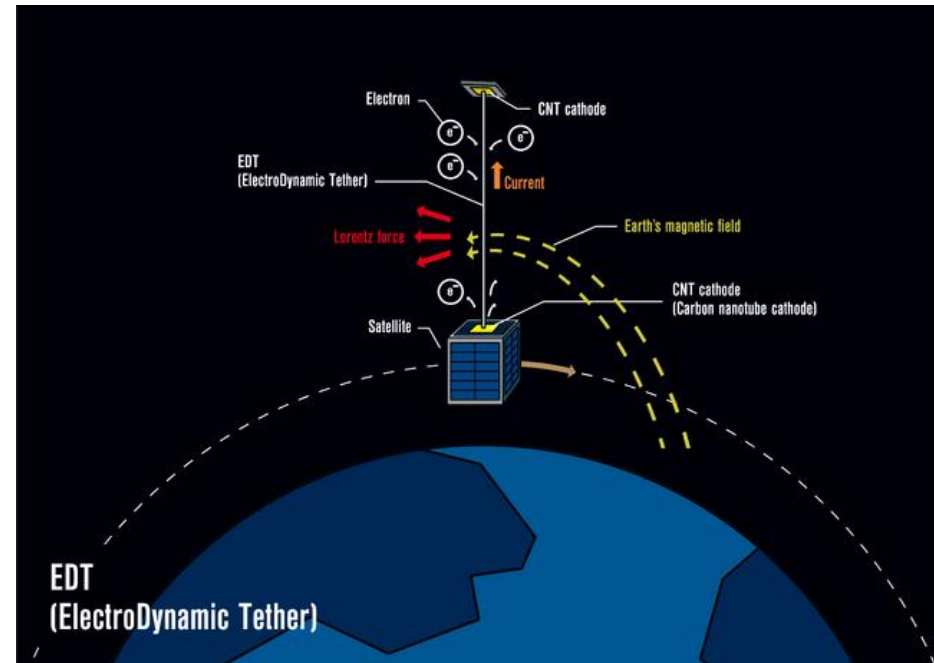
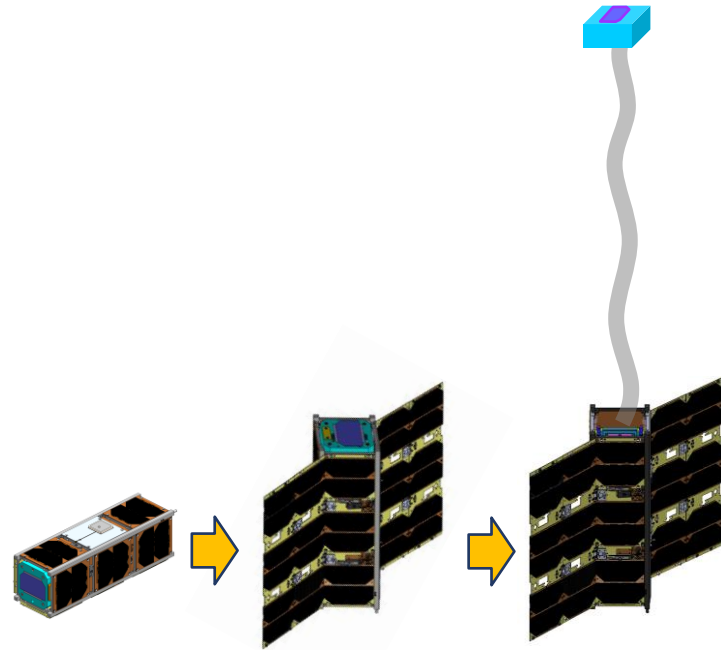

© ALE Co., Ltd.



5. Ground Station

5. Ground Station

5.1. Ground Station Setup

Ground stations consists of:

- antenna hardware
- RF components
- operation room
- operation software

Operation software consists of:

- antenna controller
- Satellite controller
- Transmitter/Receiver controller

Dish-Antenna for S-Band



Operation Room

Up-link Signal

Down-link Signal

Antenna Control

Pass ID	Date	Time	Duration
AOS@0	2013/08/09	23:35:19	
AOS@5	2013/08/09	23:36:37	
MEL	2013/08/09	23:41:42	00h 04m 25s
LOS@5	2013/08/09	23:46:49	00h 09m 32s
LOS@0	2013/08/09	23:48:08	00h 10m 51s

PASS@0 (= LOS@0 - AOS@0) 12m 48s
PASS@5 (= LOS@5 - AOS@5) 10m 12s

© Tohoku University

5. Ground Station

5.2. Components of Communication System

- Communication systems usually involve the following components in both directions - command up-link and housekeeping (HK) data/mission data down-link:
 - Computers
 - Transmitter and transmitting antenna
 - Receiver and receiving antenna
 - Cables
 - Other components such as power amplifiers
- Radio frequency (RF) cables are thick and their connectors are relatively large.



Typical CubeSat RF Transmitter and Receiver © Addnics corp.

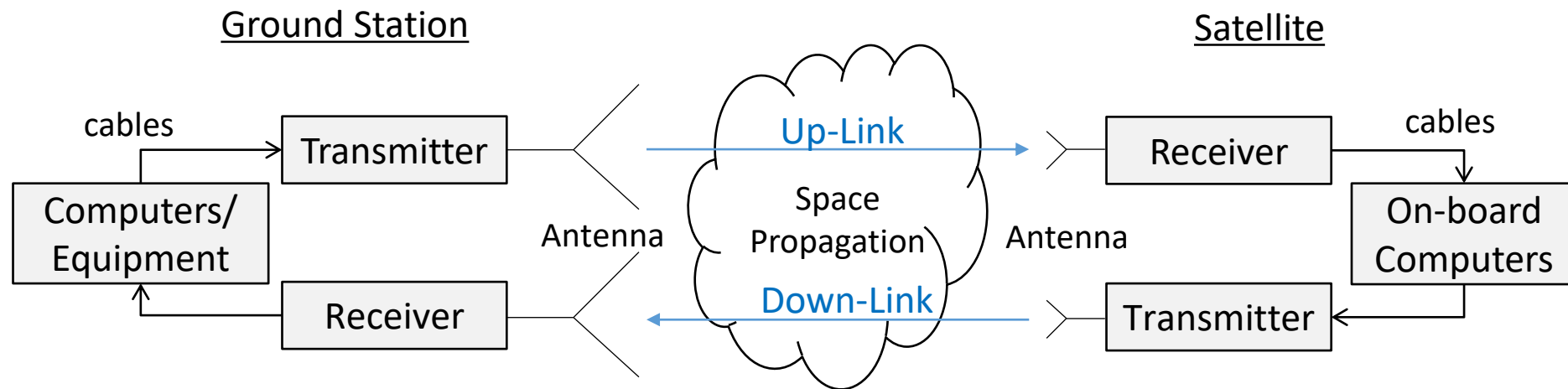

5. Ground Station

5.3. Link Budget

- The communication channel in both directions between the satellite and ground station need to be carefully designed.
- The received RF signal power at receivers shall be strong enough for a stable communication.
(Ensure a sufficient link margin!)
- The **link budget** is the relationship between data rate, antenna size, propagation path length, transmitter power, and losses through the communication channels.
- The propagation path between the satellite and the ground station is the longest at lower elevation angles (at the beginning and the end of the satellite contact), which is one of the design criteria for the link budget design.

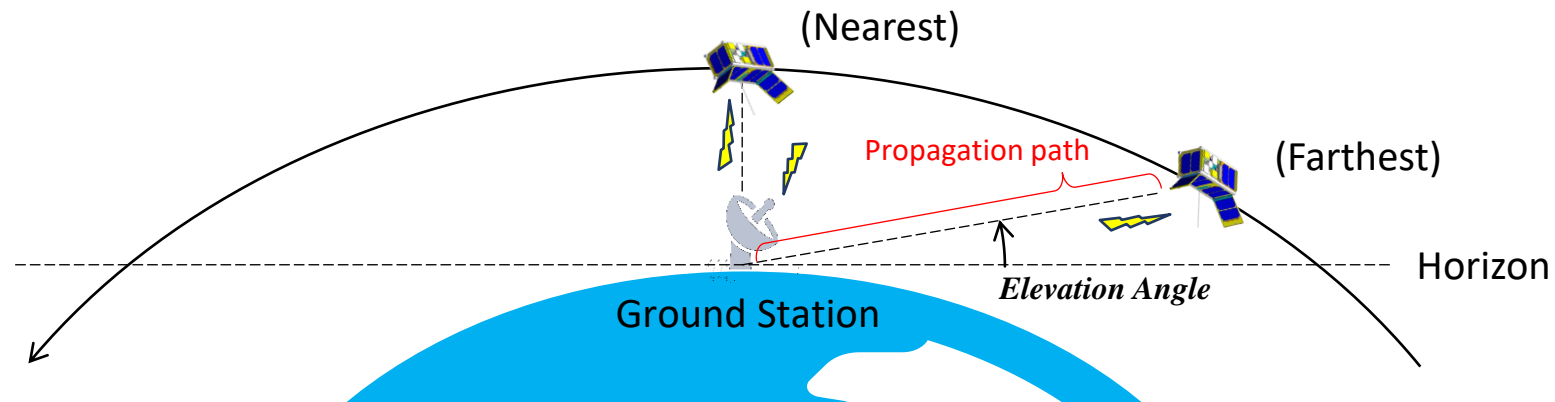

5. Ground Station

5.4. Geographical Position of the Ground Station

- The latitude of the ground track of the CubeSats deployed from the ISS is between about ± 51.6 degrees. Therefore, their ground stations need to be located in that region.
- In the low latitude region, CubeSats can approach to the ground station both from northwest and southwest. (different direction in day and night)
- The duration of the ground contact is the longest when the CubeSat flies just above the ground station. (However some ground stations cannot track satellites around the vertical direction!)
- Ground contact time, i.e., the amount of communication data can be increased by using more than one ground station, which are geographically separated.

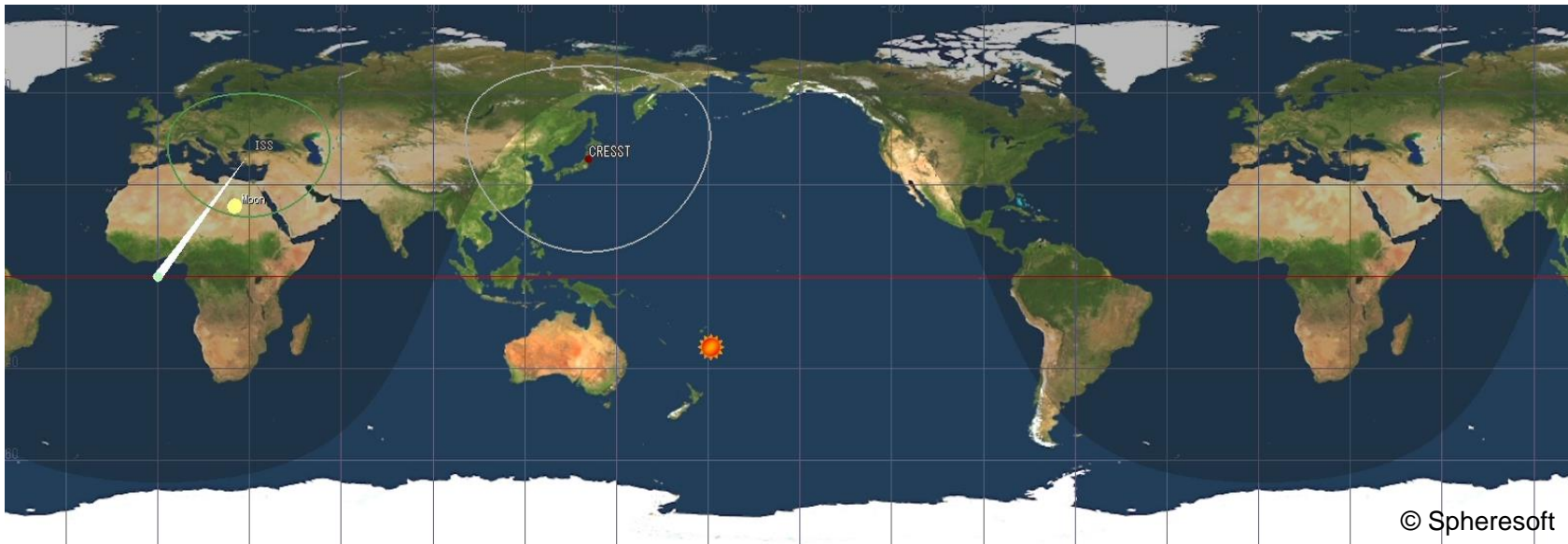



6. Launch and Operation

6. Launch and Operation

6.1. Operational Phase of CubeSat deployed from ISS

- Operational phase of the CubeSat to be deployed from the ISS can be categorized into several phases as follows.

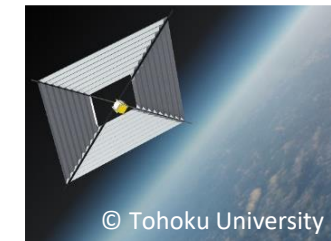
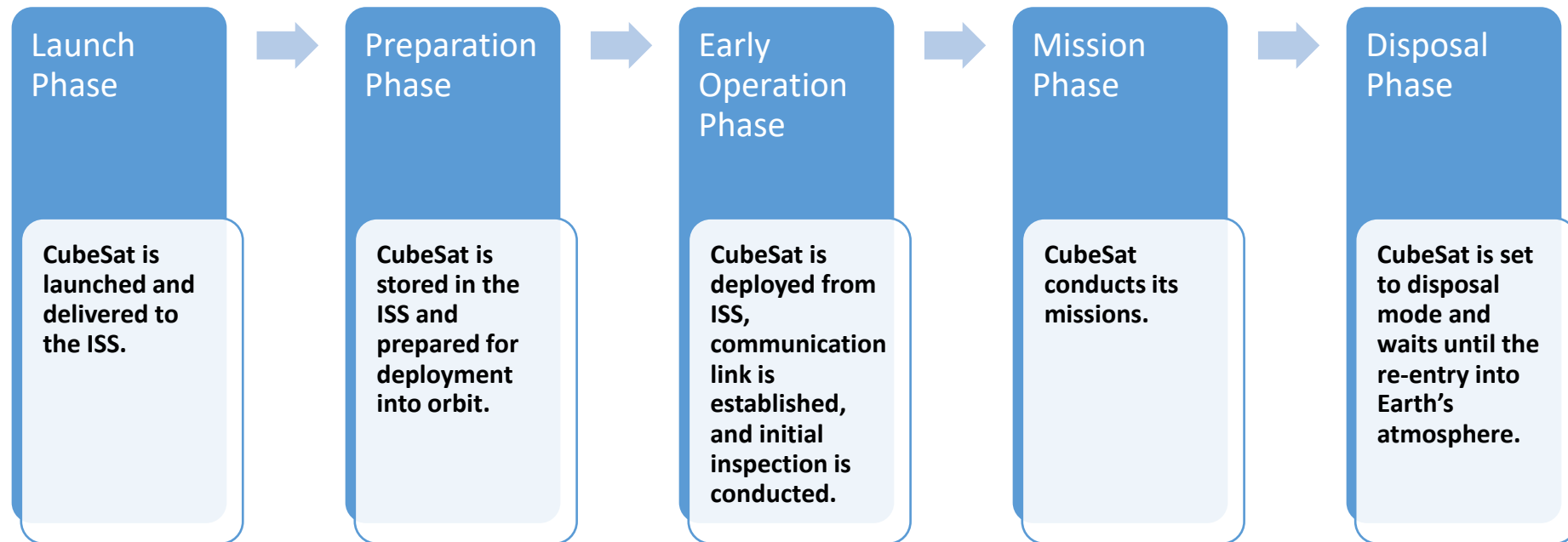

6. Launch and Operation

6.2. Preparation Phase in the ISS

- CubeSats are prepared for deployment inside the ISS by astronauts.
- The deployment mechanism is transferred to outside the ISS and attached to the tip of the robotic arm of the Kibo.
- Astronaut (or ground crew) triggers the switch for the deployment.



Deployment preparation, and deployment from the ISS © JAXA



7. Conclusion

7. Conclusion

In summary:

- The characteristics of satellite technologies and CubeSat systems are described and available where CubeSat standards are introduced.
- The functionalities of each satellite subsystem, including the payload system, are described in detail.
- Some examples of CubeSat payload devices are provided together with real satellite projects.
- Ground station components and communication link budgets between the satellites are described.
- Launch and operation aspects of CubeSats are described.



Thank you very much.

[Disclaimer]

The views and opinions expressed in this presentation are those of the authors and do not necessarily reflect those of the United Nations.